

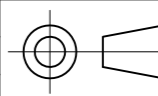

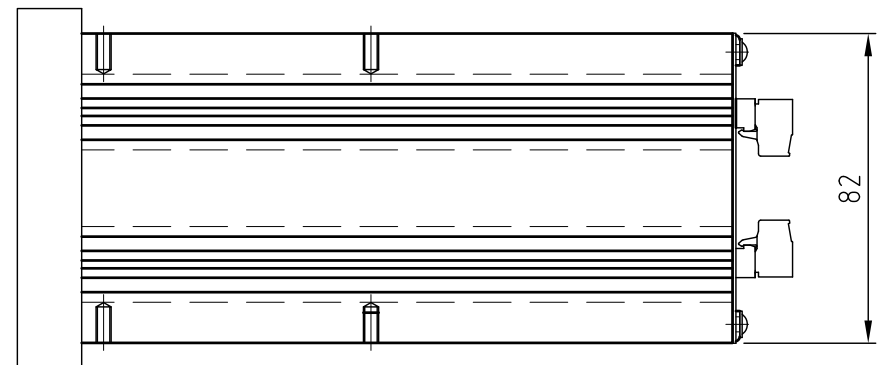

- NOTES
1. MAXIMUM WIRE DIA. IN PLUG IN TERMINALS 2.5mm
 2. DIGITAL OUTPUTS MAX. 24V/1A OR 48V/0.5A
 3. DIGITAL INPUTS ARE VOLT FREE INPUT
 4. CALIBRATION PASSWORD 3.14159

 TC PROCESS EQUIPMENT COPYRIGHT THRIVE CONSULTING PTY LTD, SYDNEY AUSTRALIA. NO PART OF THIS DRAWING MAYBE REPRODUCED WITHOUT PERMISSION			TITLE CONTINUOUS WEIGH CONTROLLER GT500E SCHEMATIC	
DRAWN CHECKED ENG. MGR. APPR'D	RHS RAS MAA	22.10.08 22.10.08 22.10.08	 SCALE 1:1	DRG No. PS0021401 REVISION 3
				A2

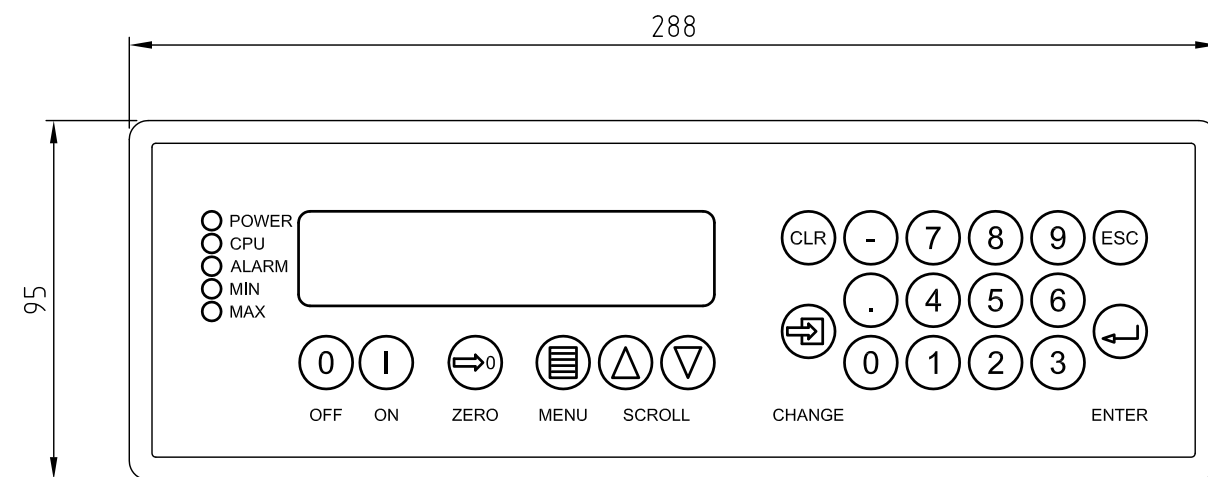
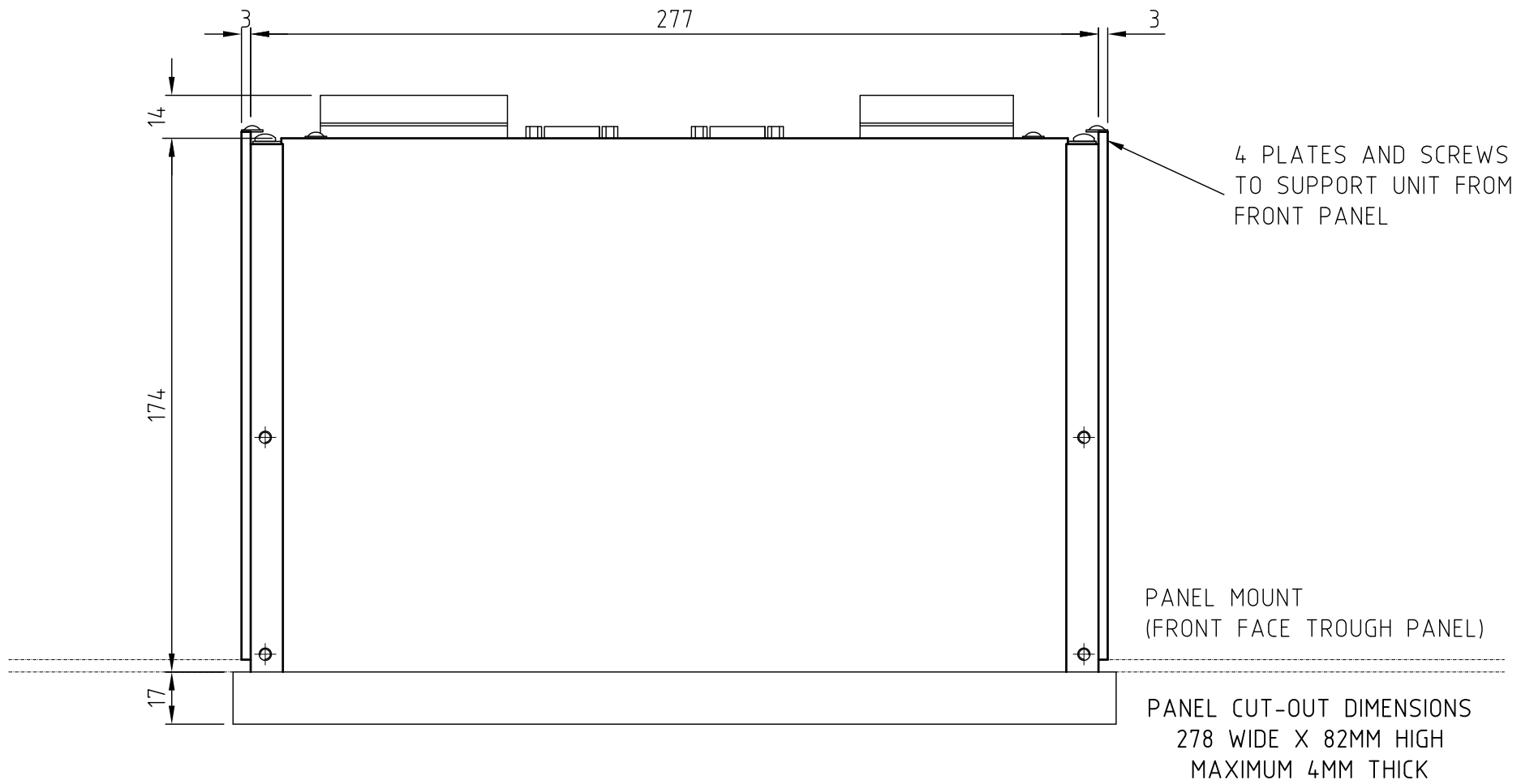

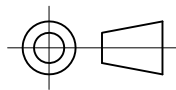
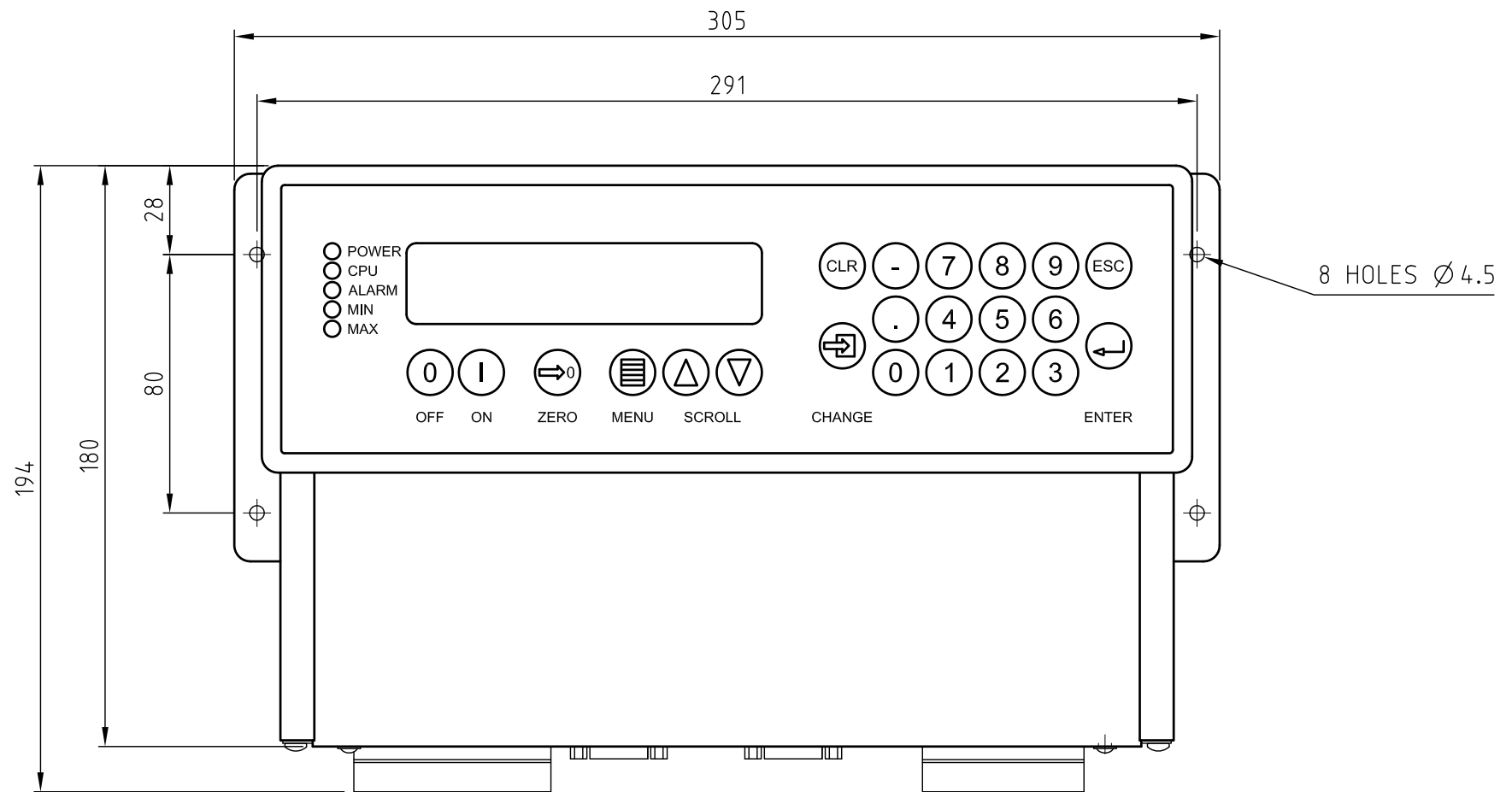
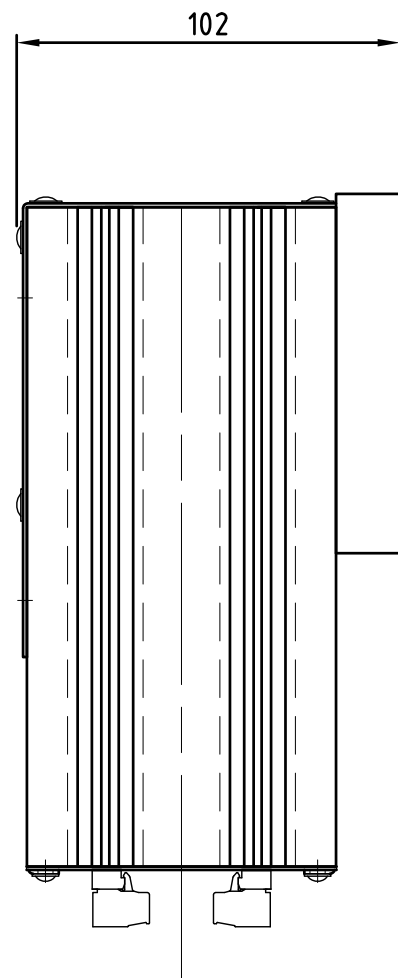
 TC			TC PROCESS EQUIPMENT COPYRIGHT THRIVE CONSULTING PTY LTD, SYDNEY AUSTRALIA. NO PART OF THIS DRAWING MAYBE REPRODUCED WITHOUT PERMISSION		TITLE GT500E CABINET PANEL MOUNTING HOUSING CONFIGURATION	
DRAWN RHS 02.04.14	CHECKED RAS 02.04.14	ENG. MGR.		DRG No. PS0021402	A3	
APPR'D MAA 02.04.14	SCALE 1:2		REVISION 0			

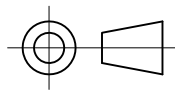

 TC			TC PROCESS EQUIPMENT		TITLE	
			COPYRIGHT THRIVE CONSULTING PTY. LTD. SYDNEY AUSTRALIA. NO PART OF THIS DRAWING MAYBE REPRODUCED WITHOUT PERMISSION		GT500E CABINET BACK PLATE HOUSING CONFIGURATION	
DRAWN	RHS	02.04.14		DRG No.		A3
CHECKED	RAS	02.04.14		PS0021403		
ENG. MGR.				SCALE 1:2		REVISION 0
APPR'D	MAA	02.04.14				